

# HD40A



## product guide

### features

- 8,818 lbs maximum load capacity
- 114'-10" maximum operating hook radius
- 101'-8" maximum hook height with jib set at 18 degrees
- 75'-6" maximum hook height with jib set at 0 degrees
- 18 different jib configurations
- Hoist speeds up to 213 ft/min with 2,205 lbs
- Trolley speeds up to 138 ft/min with max load
- Swing speeds up to 0.8 rpm with max load
- Manitowoc CraneCARE comprehensive support

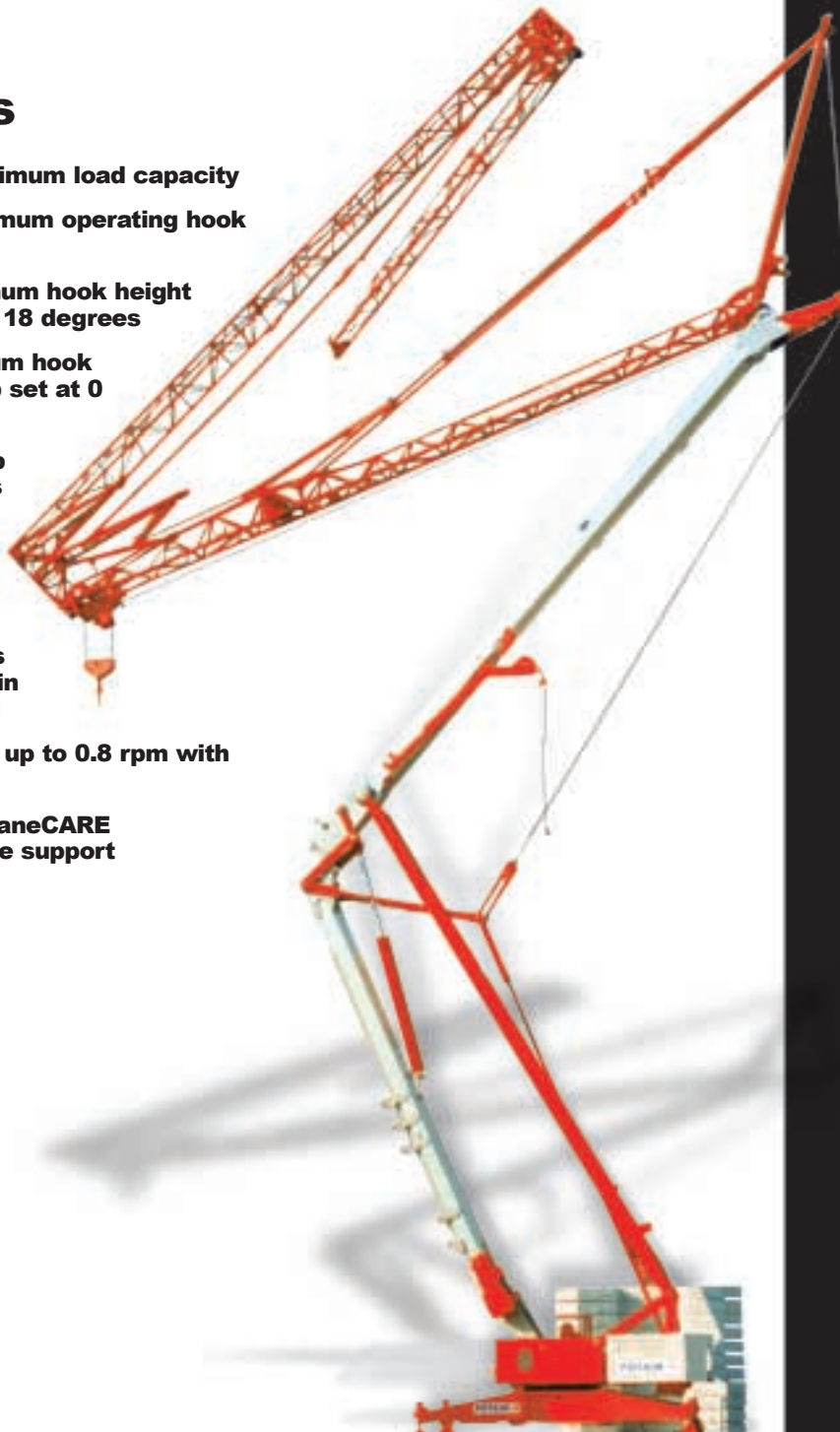

### contents

Outline  
Dimensions

2

Outline  
Dimensions

3

Rated Load  
Charts

4

Rated Load  
Charts

5

Mechanical  
Data

6

Crane Care

7

# outline dimensions

2

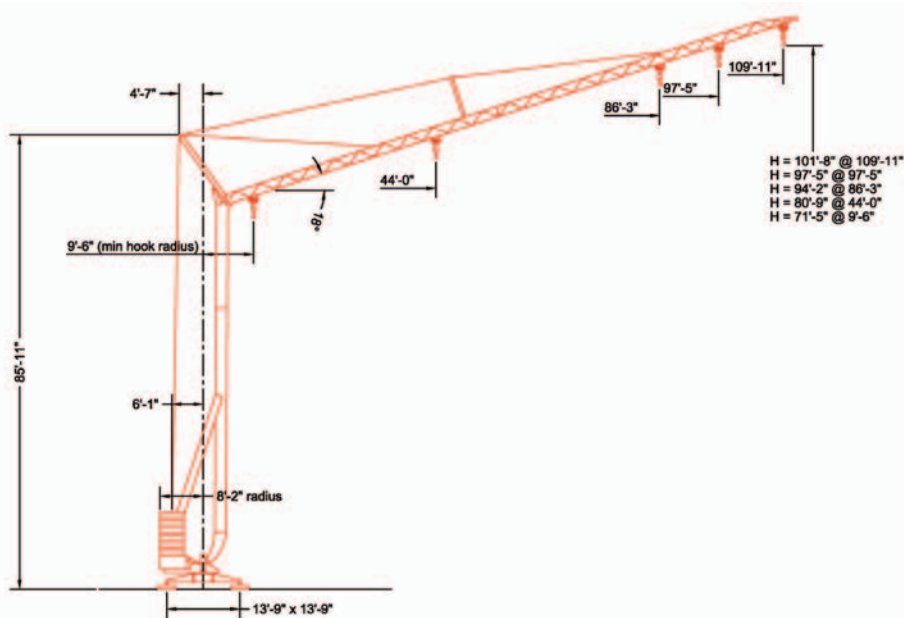
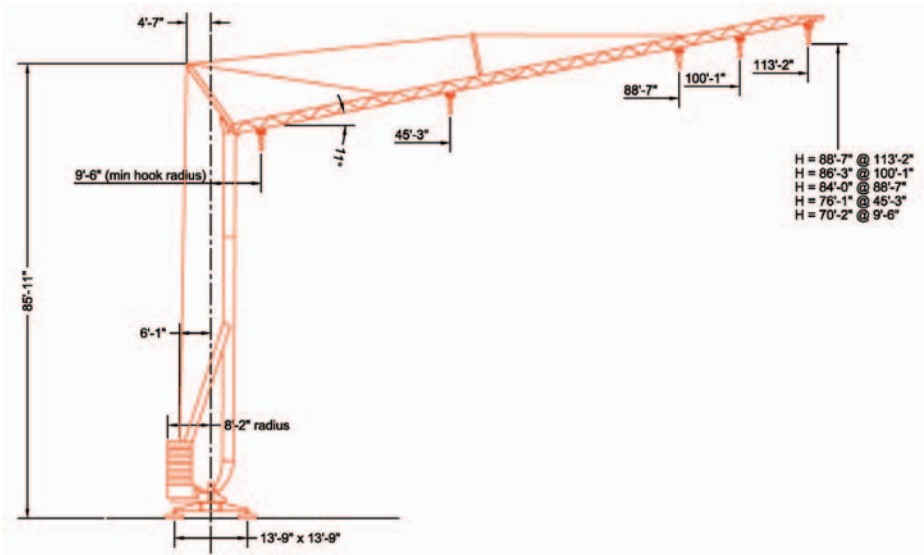
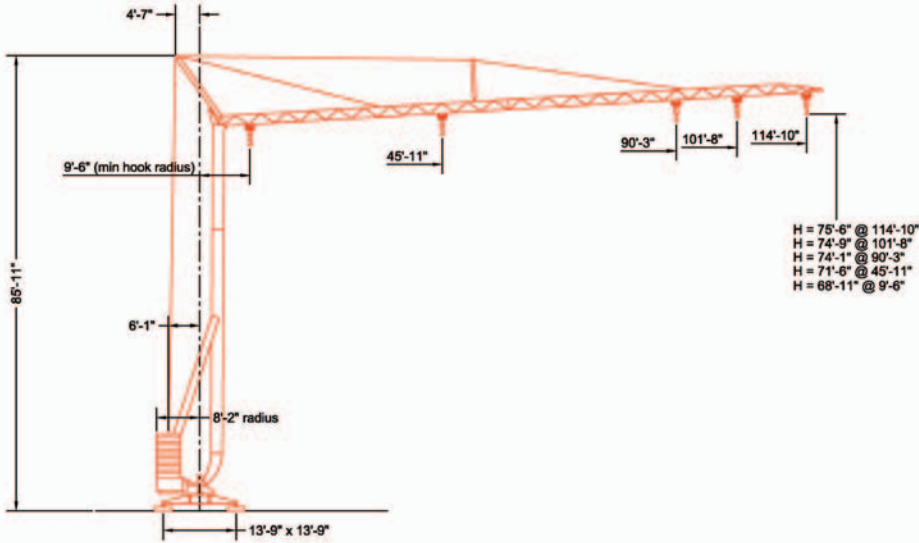

HD40A



# outline dimensions

3

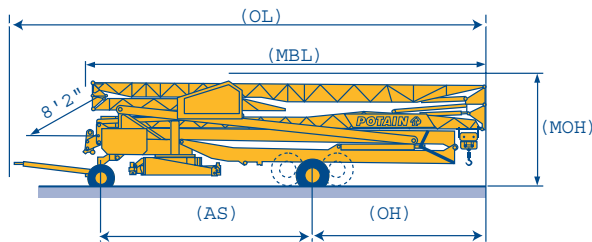
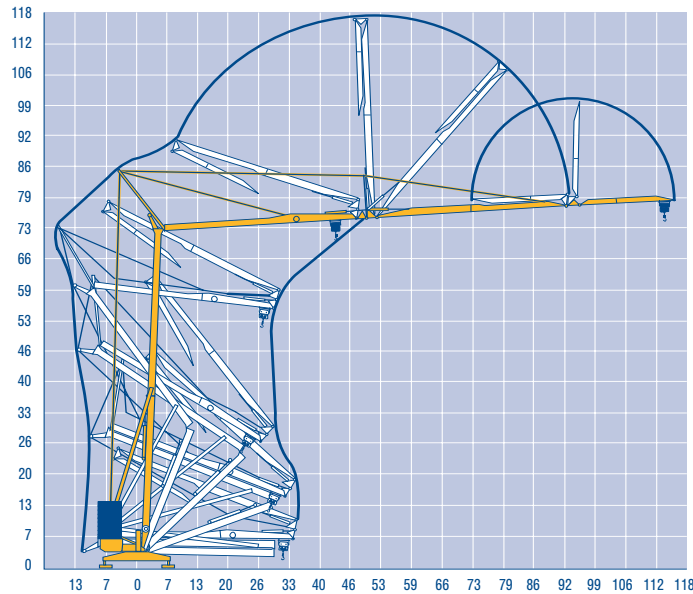

## DJ105 / S125

### Dimensions During Transport

Overall Length, (OL) =	50'-0"
Overhang, (OH) =	17'-5"
Maximum Overall Height, (MOH) =	11'-8"
Overall Width, (OW) =	8'-2"
Fifth Wheel to C.L. Rotation, (FWR) =	8'-2"
Axle Spacing, (AS) =	24'-5"

### Weights During Transport (without cab)

Total Crane - With "A" & "B" Blocks	42,681 lbs
Weight under Fifth Wheel	19,312 lbs
Weight under Rear Axle	23,369 lbs
Weight of each "A" Block	4,740 lbs
Weight of each "B" Block	3,417 lbs
Permissible Ballast During Transport	9,480 lbs

## DJ126M / S125

### Dimensions During Transport

Overall Length, (OL) =	52'-2"
Overhang, (OH) =	17'-5"
Maximum Overall Height, (MOH) =	11'-10"
Overall Width, (OW) =	8'-2"
Fifth Wheel to C.L. Rotation, (FWR) =	8'-2"
Axle Spacing, (AS) =	24'-5"

### Weights During Transport (without cab)

Total Crane - With "A" & "B" Blocks	48,281 lbs
Weight under Fifth Wheel	25,133 lbs
Weight under Rear Axle	23,149 lbs
Weight of each "A" Block	4,740 lbs
Weight of each "B" Block	3,417 lbs
Permissible Ballast During Transport	16,314 lbs

## DJ80 / S120

### Dimensions During Transport

Overall Length, (OL) =	50'-0"
Overhang, (OH) =	17'-5"
Maximum Overall Height, (MOH) =	11'-2"
Overall Width, (OW) =	8'-2"
Fifth Wheel to C.L. Rotation, (FWR) =	8'-2"
Axle Spacing, (AS) =	24'-5"

### Weights During Transport (without cab)

Total Crane - With "A" & "B" Blocks	41,579 lbs
Weight under Fifth Wheel	18,585 lbs
Weight under Rear Axle	22,994 lbs
Weight of each "A" Block	4,740 lbs
Weight of each "B" Block	3,417 lbs
Permissible Ballast During Transport	9,480 lbs

## DJ126M / S215M

### Dimensions During Transport

Overall Length, (OL) =	54'-8"
Overhang, (OH) =	17'-10"
Maximum Overall Height, (MOH) =	12'-11"
Overall Width, (OW) =	8'-2"
Fifth Wheel to C.L. Rotation, (FWR) =	10'-10"
Axle Spacing, (AS) =	26'-8"

### Weights During Transport (without cab)

Total Crane - With "A" & "B" Blocks	51,809 lbs
Weight under Fifth Wheel	22,708 lbs
Weight under Rear Axle	29,101 lbs
Weight of each "A" Block	4,740 lbs
Weight of each "B" Block	3,417 lbs
Permissible Ballast During Transport	16,314 lbs

## DJ100 / S120

### Dimensions During Transport

Overall Length, (OL) =	50'-0"
Overhang, (OH) =	17'-5"
Maximum Overall Height, (MOH) =	11'-8"
Overall Width, (OW) =	8'-2"
Fifth Wheel to C.L. Rotation, (FWR) =	8'-2"
Axle Spacing, (AS) =	24'-5"

### Weights During Transport (without cab)

Total Crane - With "A" & "B" Blocks	42,042 lbs
Weight under Fifth Wheel	19,136 lbs
Weight under Rear Axle	22,906 lbs
Weight of each "A" Block	4,740 lbs
Weight of each "B" Block	3,417 lbs
Permissible Ballast During Transport	9,480 lbs

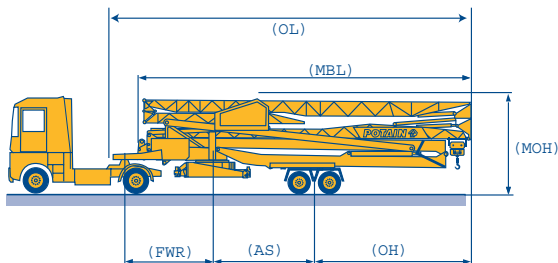

## SL121 / S215M

### Dimensions During Transport

Overall Length, (OL) =	46'-11"
Overhang, (OH) =	17'-10"
Maximum Overall Height, (MOH) =	13'-1"
Overall Width, (OW) =	8'-2"
Fifth Wheel to C.L. Rotation, (FWR) =	11'-2"
Axle Spacing, (AS) =	27'-0"

### Weights During Transport (without cab)

Total Crane - With "A" & "B" Blocks	50,596 lbs
Weight under Fifth Wheel	20,944 lbs
Weight under Rear Axle	29,652 lbs
Weight of each "A" Block	4,740 lbs
Weight of each "B" Block	3,417 lbs
Permissible Ballast During Transport	16,314 lbs

## SL122 / J215M

### Dimensions During Transport

Overall Length, (OL) =	46'-11"
Overhang, (OH) =	17'-10"
Maximum Overall Height, (MOH) =	13'-1"
Overall Width, (OW) =	8'-2"
Fifth Wheel to C.L. Rotation, (FWR) =	11'-2"
Axle Spacing, (AS) =	27'-0"

### Weights During Transport (without cab)

Total Crane - With "A" & "B" Blocks	50,486 lbs
Weight under Fifth Wheel	21,054 lbs
Weight under Rear Axle	29,873 lbs
Weight of each "A" Block	4,740 lbs
Weight of each "B" Block	3,417 lbs
Permissible Ballast During Transport	16,314 lbs

## SL121 / J135

### Dimensions During Transport

Overall Length, (OL) =	46'-11"
Overhang, (OH) =	18'-2"
Maximum Overall Height, (MOH) =	12'-8"
Overall Width, (OW) =	8'-2"
Fifth Wheel to C.L. Rotation, (FWR) =	11'-2"
Axle Spacing, (AS) =	26'-8"

### Weights During Transport (without cab)

Total Crane - With "A" & "B" Blocks	48,810 lbs
Weight under Fifth Wheel	20,613 lbs
Weight under Rear Axle	28,197 lbs
Weight of each "A" Block	4,740 lbs
Weight of each "B" Block	3,417 lbs
Permissible Ballast During Transport	16,314 lbs

\*Note: All dimensions are in feet  
All weights in pounds

\*Note: For all transport configurations the main body length,  
(MBL) = 43'4".

HD40A



# rated load charts

4

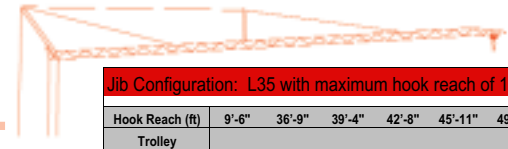

**Jib Configuration: L35 with maximum hook reach of 114'-10" set at 0 degrees**

Hook Reach (ft)	9'-6"	36'-9"	39'-4"	42'-8"	45'-11"	49'-3"	52'-6"	55'-9"	59'-1"	62'-4"	65'-7"	72'-2"	78'-9"	85'-4"	91'-10"	95'-2"	101'-8"	108'-3"	114'-10"
Trolley	Capacities (lbs)																		
SM/DM	8,818	8,818	8,146	7,385	6,746	6,195	5,732	5,324	4,971	4,663	4,376	3,902	3,516	3,186	2,910	2,789	2,568	2,381	2,205

Maximum Hook Height at Jib Tip: H = 75'-6"  
Maximum Hook Height at Jib Foot: H = 68'-11"



**Jib Configuration: L31 with maximum hook reach of 101'-8" set at 0 degrees**

Hook Reach (ft)	9'-6"	40'-0"	42'-8"	45'-11"	49'-3"	52'-6"	55'-9"	59'-1"	62'-4"	65'-7"	72'-2"	78'-9"	85'-4"	91'-10"	95'-2"	101'-8"
Trolley	Capacities (lbs)															
SM/DM	8,818	8,818	8,157	7,452	6,856	6,349	5,908	5,512	5,170	4,861	4,332	3,902	3,549	3,241	3,109	2,866

Maximum Hook Height at Jib Tip: H = 74'-9"  
Maximum Hook Height at Jib Foot: H = 68'-11"



**Jib Configuration: L35 with maximum hook reach of 90'-3" set at 0 degrees**

Hook Reach (ft)	9'-6"	38'-1"	39'-4"	42'-8"	45'-11"	49'-3"	52'-6"	55'-9"	59'-1"	62'-4"	65'-7"	72'-2"	78'-9"	85'-4"	90'-3"
Trolley	Capacities (lbs)														
SM/DM	8,818	8,818	8,422	7,628	6,978	6,415	5,930	5,512	5,148	4,828	4,542	4,045	3,638	3,307	3,086

Maximum Hook Height at Jib Tip: H = 74'-1"  
Maximum Hook Height at Jib Foot: H = 68'-11"



**Jib Configuration: L31 with maximum hook reach of 90'-3" set at 0 degrees**

Hook Reach (ft)	9'-6"	38'-1"	39'-4"	42'-8"	45'-11"	49'-3"	52'-6"	55'-9"	59'-1"	62'-4"	65'-7"	72'-2"	78'-9"	85'-4"	90'-3"
Trolley	Capacities (lbs)														
SM/DM	8,818	8,818	8,422	7,628	6,978	6,415	5,930	5,512	5,148	4,828	4,542	4,045	3,638	3,307	3,086

Maximum Hook Height at Jib Tip: H = 74'-1"  
Maximum Hook Height at Jib Foot: H = 68'-11"

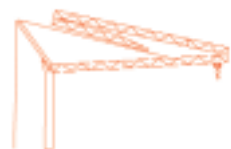

**Jib Configuration: L35 with maximum hook reach of 45'-11" set at 0 degrees**

Hook Reach (ft)	9'-6"	45'-11"
Trolley	Capacities (lbs)	
SM/DM	8,818	8,818

Maximum Hook Height at Jib Tip: H = 71'-6"  
Maximum Hook Height at Jib Foot: H = 68'-11"

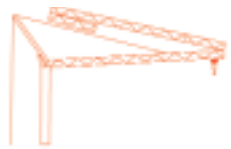

**Jib Configuration: L31 with maximum hook reach of 45'-11" set at 0 degrees**

Hook Reach (ft)	9'-6"	45'-11"
Trolley	Capacities (lbs)	
SM/DM	8,818	8,818

Maximum Hook Height at Jib Tip: H = 71'-6"  
Maximum Hook Height at Jib Foot: H = 68'-11"

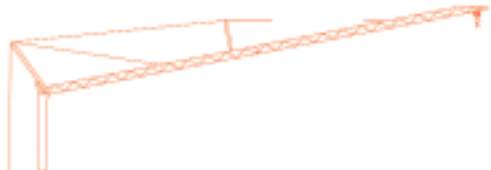

**Jib Configuration: L35 with maximum hook reach of 113'-2" set at 11 degrees**

Hook Reach (ft)	9'-6"	64'-4"	72'-2"	82'-0"	88'-7"	98'-5"	105'-0"	113'-2"
Trolley	Capacities (lbs)							
SM	4,409	4,409	3,836	3,285	2,987	2,624	2,425	2,205

Maximum Hook Height at Jib Tip: H = 88'-7"  
Maximum Hook Height at Jib Foot: H = 70'-2"



**Jib Configuration: L31 with maximum hook reach of 100'-1" set at 11 degrees**

Hook Reach (ft)	9'-6"	69'-11"	72'-2"	82'-0"	88'-7"	100'-1"
Trolley	Capacities (lbs)					
SM	4,409	4,409	4,255	3,649	3,329	2,866

Maximum Hook Height at Jib Tip: H = 86'-3"  
Maximum Hook Height at Jib Foot: H = 70'-2"

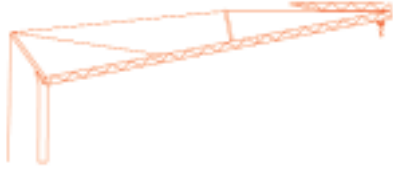

**Jib Configuration: L35 with maximum hook reach of 88'-7" set at 11 degrees**

Hook Reach (ft)	9'-6"	65'-11"	72'-2"	82'-0"	88'-7"
Trolley	Capacities (lbs)				
SM	4,409	4,409	3,957	3,395	3,086

Maximum Hook Height at Jib Tip: H = 84'-0"  
Maximum Hook Height at Jib Foot: H = 70'-2"

HD40A



# rated load charts

5

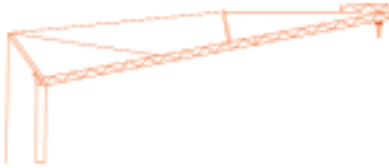

Jib Configuration: L31 with maximum hook reach of 88'-7" set at 11 degrees										
Hook Reach (ft)	9'-6"	65'-11"	72'-2"	82'-0"	88'-7"					
Trolley	Capacities (lbs)									
SM	4,409	4,409	3,957	3,395	3,086					
Maximum Hook Height at Jib Tip: H = 84'-0"										
Maximum Hook Height at Jib Foot: H = 70'-2"										

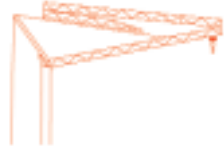

Jib Configuration: L35 with maximum hook reach of 45'-3" set at 11 degrees										
Hook Reach (ft)	9'-6"	45'-3"								
Trolley	Capacities (lbs)									
SM	4,409	4,409								
Maximum Hook Height at Jib Tip: H = 76'-1"										
Maximum Hook Height at Jib Foot: H = 70'-2"										

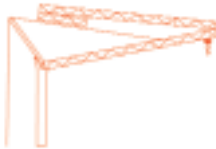

Jib Configuration: L31 with maximum hook reach of 45'-3" set at 11 degrees										
Hook Reach (ft)	9'-6"	45'-3"								
Trolley	Capacities (lbs)									
SM	4,409	4,409								
Maximum Hook Height at Jib Tip: H = 76'-1"										
Maximum Hook Height at Jib Foot: H = 70'-2"										

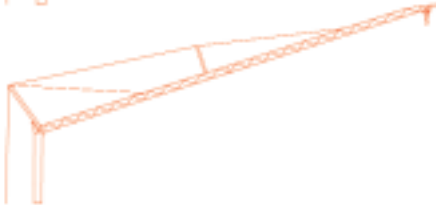

Jib Configuration: L35 with maximum hook reach of 109'-11" set at 18 degrees										
Hook Reach (ft)	9'-6"	109'-11"								
Trolley	Capacities (lbs)									
SM	2,205	2,205								
Maximum Hook Height at Jib Tip: H = 101'-8"										
Maximum Hook Height at Jib Foot: H = 71'-5"										

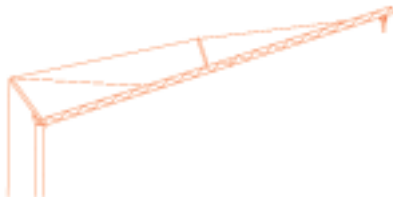

Jib Configuration: L31 with maximum hook reach of 97'-5" set at 18 degrees										
Hook Reach (ft)	9'-6"	97'-5"								
Trolley	Capacities (lbs)									
SM	2,205	2,205								
Maximum Hook Height at Jib Tip: H = 97'-5"										
Maximum Hook Height at Jib Foot: H = 71'-5"										



Jib Configuration: L35 with maximum hook reach of 86'-3" set at 18 degrees										
Hook Reach (ft)	9'-6"	86'-3"								
Trolley	Capacities (lbs)									
SM	2,205	2,205								
Maximum Hook Height at Jib Tip: H = 94'-2"										
Maximum Hook Height at Jib Foot: H = 71'-5"										

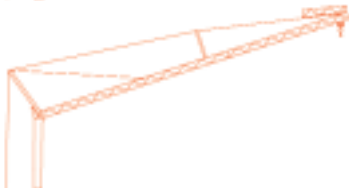

Jib Configuration: L31 with maximum hook reach of 86'-3" set at 18 degrees										
Hook Reach (ft)	9'-6"	86'-3"								
Trolley	Capacities (lbs)									
SM	2,205	2,205								
Maximum Hook Height at Jib Tip: H = 94'-2"										
Maximum Hook Height at Jib Foot: H = 71'-5"										



Jib Configuration: L35 with maximum hook reach of 44'-0" set at 18 degrees										
Hook Reach (ft)	9'-6"	44'-0"								
Trolley	Capacities (lbs)									
SM	2,205	2,205								
Maximum Hook Height at Jib Tip: H = 80'-9"										
Maximum Hook Height at Jib Foot: H = 71'-5"										



Jib Configuration: L31 with maximum hook reach of 44'-0" set at 18 degrees										
Hook Reach (ft)	9'-6"	44'-0"								
Trolley	Capacities (lbs)									
SM	2,205	2,205								
Maximum Hook Height at Jib Tip: H = 80'-9"										
Maximum Hook Height at Jib Foot: H = 71'-5"										

HD40A



# mechanical data

6

Function	Hoist Type	Speed vs Weight	2-part				4-part				Motor (hp)	Motor (kW)
			1st Gear	2nd Gear	3rd Gear	4th Gear	1st Gear	2nd Gear	3rd Gear	4th Gear		
Hoist	15 RPC 10	ft/min lbs	35 4,409	106 4,409	213 2,205		18 8,818	53 8,818	106 4,409		18	13
	15 LVF 10 Optional	ft/min lbs	16 4,409	89 4,409	141 2,756	174 2,205	8 8,818	44 8,818	71 5,512	87 4,409	18	13
Trolley	3 D2 V5	ft/min	69 to 138								3.2	2.4
Swing	RVF 2 30	rpm	0.8								3.5	2.6

**Power Requirements:** 480 V (+6% or -10%) 60 Hz measured at turn table.  
**Amperage:** 15 LVF 10: 29 Amp (3 phase service with ground)  
**Amperage:** 15 RPC 10: 29 Amp (3 phase service with ground)

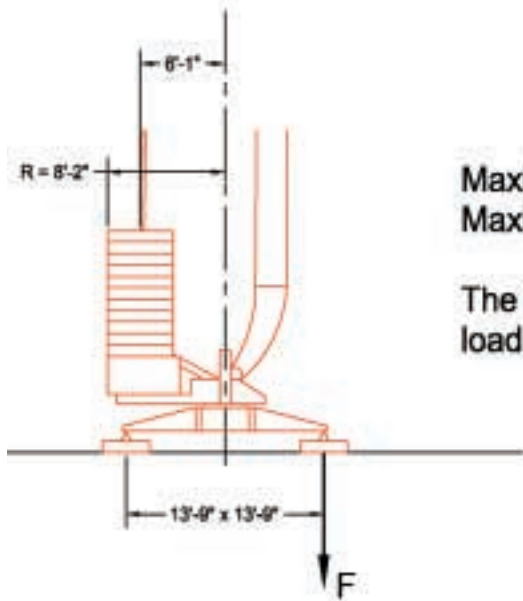

**Maximum In-Service Corner Force;  $F = 49,604$  lbs**  
**Maximum Out of Service Corner Force;  $F = 34,833$  lbs**

The weight of the machine with full jib and without load, ballast, or transport axles is 27,117 lbs

## Warning Systems

**Limit Moment Cut-Out** – Prevents a moment that is more than +10%.

## Warning

1. The operator must read and understand the owner's manual before operating this crane.
2. Positioning or operation of crane beyond areas shown is not intended or approved except where specified in owner's manual.
3. Practical working loads depend on supporting surface, wind, and other factors affecting stability such as hazardous surroundings, experience of personnel, and proper handling, all of which must be taken into account by the operator.

**HD40A**



# CraneCARE

CraneCARE is Manitowoc's complete service and support program. Incorporated into this program are service training, immediate parts availability, professional field service, and technical support and documentation. CraneCARE is available for every one of the thousands of cranes operating all over the world.

That's dedication and devotion that you won't get anywhere else.

That's **CraneCARE**.

## Service Training

A certified Manitowoc service specialist works with you in your training facility or in the field to ensure that you know how to achieve maximum performance, dependability, and years from your cranes.

A reputable Manitowoc Service technician comes to you to provide valuable training to all distributors on the crane's LMI system.

## Parts Availability

Genuine Manitowoc replacement parts may be obtained through your MCG distributor on a regular basis.

## Field Service

Factory-trained service experts are always ready to help maintain your crane's peak performance.

For a worldwide listing of dealer locations, please consult our website at: [www.manitowoccranes.com](http://www.manitowoccranes.com).

## Technical Support

Manitowoc's dealer network and factory personnel are available 24 hours a day, 7 days a week, 365 days a year to answer your technical questions and more. **7**

For a worldwide listing of dealer locations, please consult our website at: [www.manitowoccranes.com](http://www.manitowoccranes.com).

## Technical Documentation

Manitowoc boasts an extensive, easy-to-understand library of documentation.

A complete set of Operator's parts and service manuals are included with each crane.

Additional copies are available through your Authorized Manitowoc Distributor.

HD40A





**Manitowoc Crane Group - Americas**

Manitowoc, Wisconsin Facility  
Tel: [Int + 001] 920 684 6621  
Fax: [Int + 001] 920 683 6277  
Shady Grove, Pennsylvania Facility  
Tel: [Int + 001] 717 597 8121  
Fax: [Int + 001] 717 597 4062

**Manitowoc Crane Group - EMEA**

Europe Middle East & Africa  
Tel: [Int + 33] (0) 4 72 18 20 20  
Fax: [Int + 33] (0) 4 72 18 20 00

**Manitowoc Crane Group - UK**

Europe Middle East & Africa (Parts & Service)  
Tel: [Int + 44] (0) 191 565-6281  
Fax: [Int + 44] (0) 191 564-0442

**Manitowoc Crane Group - Germany**

(Sales, Parts & Service)  
Tel: [Int + 49] (0) 2173 8909-0  
Fax: [Int + 49] (0) 2173 8909-30

**Manitowoc Crane Group - France**

France & Africa (Sales, Parts & Service)  
Tel: [Int + 33] (0) 1 303-13150  
Fax: [Int + 33] (0) 1 303-86085

**Manitowoc Crane Group - Netherlands**

(Sales, Parts & Service)  
Tel: [Int + 31] (0) 76 578 39 99  
Fax: [Int + 31] (0) 76 578 39 78

**Manitowoc Crane Group - Italy**

Italy & Southern Europe (Sales, Parts & Service)  
Tel: [Int + 39] (0) 331 49 33 11  
Fax: [Int + 39] (0) 331 49 33 30

**Manitowoc Crane Group - Portugal**

Portugal & Spain (Sales, Parts & Service)  
Tel: [Int + 351] (0) 22 968 08 89  
Fax: [Int + 351] (0) 22 968 08 97

**Manitowoc Crane Group - Singapore**

Asia/Pacific excl China (Sales, Parts & Service)  
Tel: [Int + 65] 6861-7133  
Fax: [Int + 65] 6862-4040 / 4142

**Manitowoc Crane Group - Shanghai**

China (Sales, Parts & Service)  
Tel: [Int + 86] (0) 21-64955555  
Fax: [Int + 86] (0) 21-64852038

**Manitowoc Crane Group - Beijing**

China (Sales, Parts & Service)  
Tel: [Int + 86] (0) 10 646-71690  
Fax: [Int + 86] (0) 10 646-71691

**Manitowoc Crane Group - Middle East**

(Sales)  
Tel: [Int + 971] (0) 4 348-4478  
Fax: [Int + 971] (0) 4 348-4478  
(Parts & Service)  
Tel: [Int + 973] (0) 9 660-899  
Fax: [Int + 973] (0) 2 707-740

Distributed By:



[www.manitowoccrane.com](http://www.manitowoccrane.com)

Constant improvement and engineering progress make it necessary that we reserve the right to make specification, equipment, and price changes without notice. Illustrations shown may include optional equipment and accessories, and may not include all standard equipment.